

Series 650
"MULTI - SAUT" BAC DE CUISSON
"MULTI - BRATER"

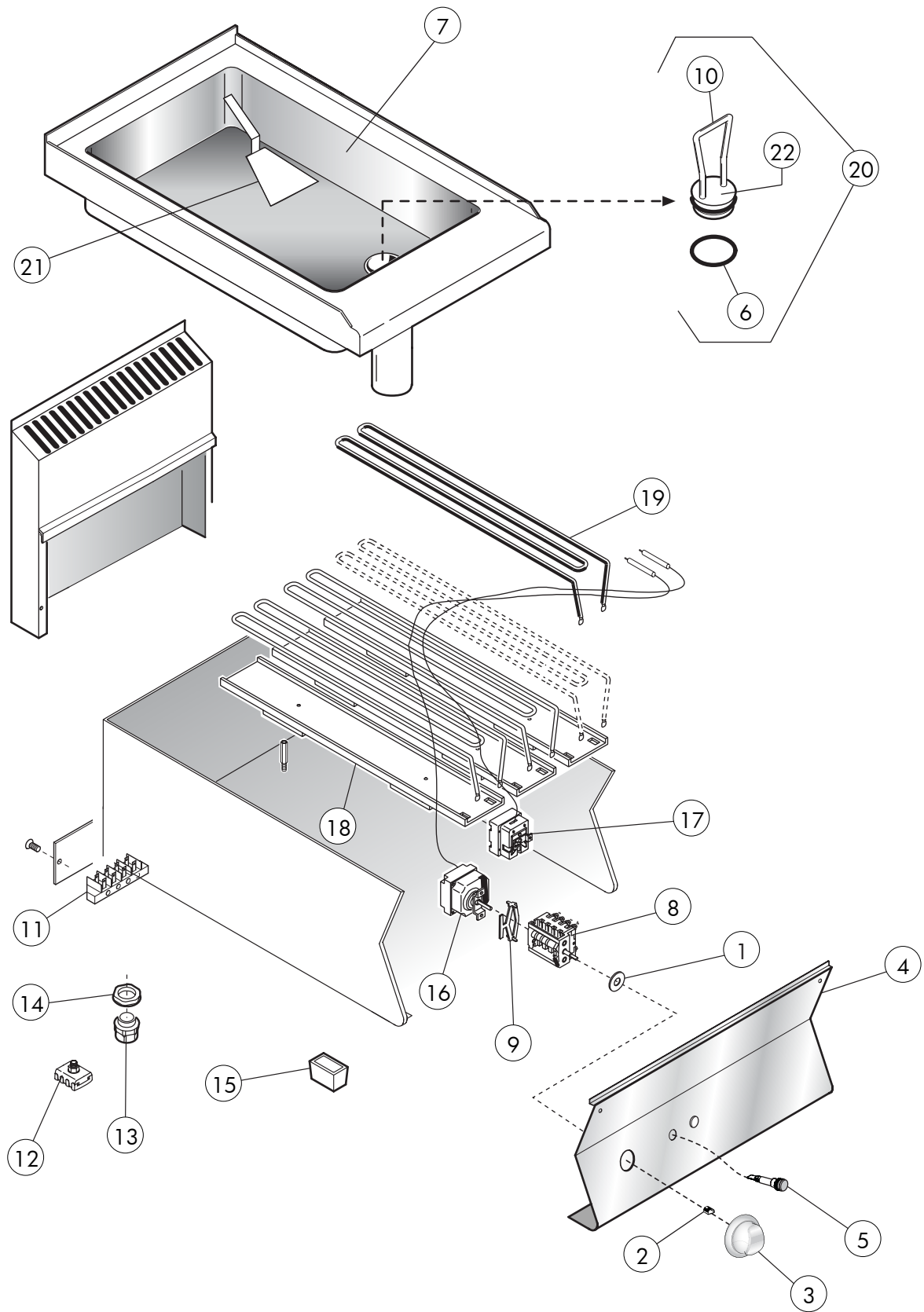

Table_A

EDITION 01 2012

0856169 6NBF E-400

Series 650

"Multi-saut" bac de cuisson
"Multi-brater"

Table_A

POS.	CODE	PIECES	DESCRIPTION	BESCHREIBUNG	DATA	C
1	CR0587650	1	GARNITURE ILS PLANTENT DES ARBRES	DICHTUNG AM ENERGIERE		
2	MA9003088700	1	RESSORT	SPRINGFEDER		
3	CR0932270	1	MANETTE	DREHKNOPF		
4	CR0931530	1	PANNEAU FRONTAL	FRONTBLENDE		
5	CR0587500	1	VOYANT ORANGE	ORANGE LEUCHE		
6	CR0413880	1	GARNITURE	DICHTUNG		
7	CR0931780	1	PLATE - M60	PLATTE -M60		
8	MA710300	1	INTERRUPTEUR EGO	SCHALTER EGO		
9	MA921200	1	ÉTRIER EGO	HALTERUNG EGO		
10	CR0413890	1	MANCHE BOUCHON	HANDLE GAP		
11	CR0588170	1	BORNIERE 6 POLES	6-POLIGE KLEMMLEISTE		
12	MA1878400	1	BORNIERE A PEIGNE	KAMM-KLEMMLEISTE		
13	MA1037112400	1	PRESSE-CABLE	KABELPRESSE		
14	MA1037114500	1	CONTRE-ECRU	GEGENMUTTER		
15	MA1036021613	4	PIED	FUSS		
16	MA1309115	1	THERMOSTAT 0-300°C	THERMOSTAT 0-300°C		
17	MA1878500	1	THERMOSTAT 360°C EGOS	SICHERHEITSTERMOSTAT 360°C EGO		
18	MA1044358300	3	SOUTIENS - RÉSISTANCES	HEIZUNGSTRÄGERGEHÄUSE		
19	MA1037317700	3	RÉSISTANCE 1300W 230V	HEIZUNG 1300W 230V		
20	CR0414040	1	BOUCHON MONTÉ	GAP MONTAGE		
21	MA1030000600	1	PELLE POUR FRY-TOP LISSE	KRAPZER		
22	MA1033206801	1	BOUCHON	GAP		

* >>> Rechange conseillé - Empfohlener Austausch