

Mod	(D)74/10CTEE (Q)70TPF/EE800												
P(KW)	16.0												
I(A)	25												
U(V)	380-415V 3N~												
f(Hz)	50/60												
Cable	5G2.5mm <sup>2</sup>												
MA	<table border="1"> <tr> <td>1</td> <td>2</td> <td>3</td> <td>4</td> <td>5</td> <td>⊥</td> </tr> <tr> <td>L1</td> <td>L2</td> <td>L3</td> <td>N</td> <td></td> <td></td> </tr> </table>	1	2	3	4	5	⊥	L1	L2	L3	N		
1	2	3	4	5	⊥								
L1	L2	L3	N										
	380-415V 3N~												

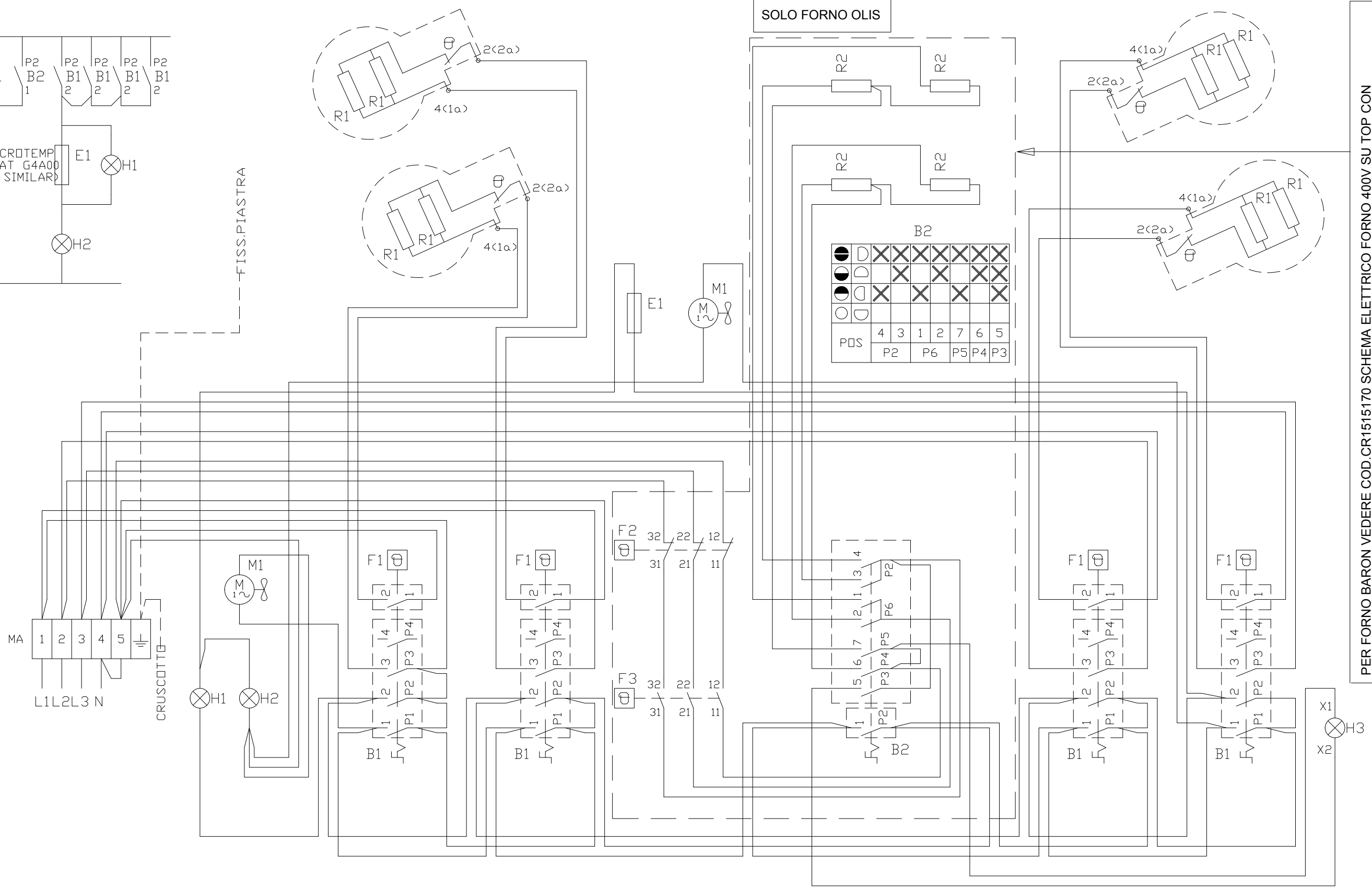

PER FORNO BARON VEDERE COD. CR1515170 SCHEMA ELETRICO FORNO 400V SU TOP CON APPLICAZIONE ELETTRICA - CUCINA ELETTRICA, CUCINA VETROCERAMICA E TUTTAPIASTRA ELETRICO

B1	INTERRUTTORE	INTERRUPTEUR	CUT-OFF SWITCH	EIN-AUS SCHALTER	B2	COMMUTATORE FORNO	COMMUTEUR FOUR	OVEN CHANGE-OVER SWITCH	BACKOFEN UMSCHALTER
F1	TERMOSTATO DI LAVORO	THERMOSTAT	THERMOSTAT	THERMOSTAT	F3	TERMOSTATO FORNO	THERMOSTAT FOUR	OVEN THERMOSTAT	BACKOFEN THERMOSTAT
E1	TERMOFUSIBILE	THERMO-FUSIBLE	THERMO-FUSE	TEMPERATUR SICHERUNG	F2	TERMOSTATO DI SICUREZZA	THERMOSTAT DE SICURITE'	SAFETY THERMOSTAT	TEMPERATURBEGRENZER
H1	SPIA ROSSA	LAMPE ROUGE	RED PILOTLIGHT	ROT LAMPE	H3	SPIA ARANCIO	LAMPE ORANGE	ORANGE PILOTLIGHT	ORANGE LAMPE
H2	SPIA ARANCIO	LAMPE ORANGE	ORANGE PILOTLIGHT	ORANGE LAMPE	R2	RESISTENZA FORNO	RESISTANCE FOUR	OVEN HEATING	BACKOFEN HEIZKORPER
MA	MORSETTIERA ARRIVO LINEA	BORNES ARRIVEE LIGNE	TERMINAL BLOCK	ANSCHLUSSKLEMME					
M1	VENTILATORE	VENTILATEUR	FAN	VENTILATOR					
R1	RESISTENZA	RESISTANCE	HEATING ELEMENT	HEIZKORPER					

Code	CR1516420		Drawing Description	SCHEMA ELE. TUTTAP.ELE.700 SU FORNO OL/BA		Rev.	00
Author	BOTTEGA		Document Type			Description	
Date	10/06/2021						This document is exclusive property of ALI GROUP and should not be distributed, reproduced, into any other format without prior permission of ALI GROUP - Specifications subject to change without prior notice -

21022B	00	PRIMA EMISSIONE	21/06/2021	TEGNER
Rif	Rev	Description	Date	Author

0W sotto 3000W sopra			3000W sotto 0W sopra			3000W sotto 3000W sopra		
L1	L2	L3	L1	L2	L3	L1	L2	L3
0W	1500W	1500W	0W	1500W	1500W	0W	3000W	3000W

TOTALE POTENZE

L1	L2	L3
0W	3000W	3000W
6000W		

94/04-96/04CGE  
94/04-96/04CGEP  
94/04-96/04CTGE

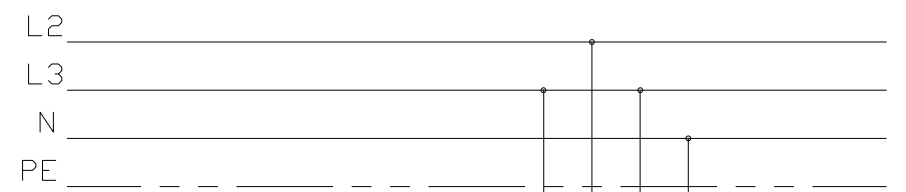
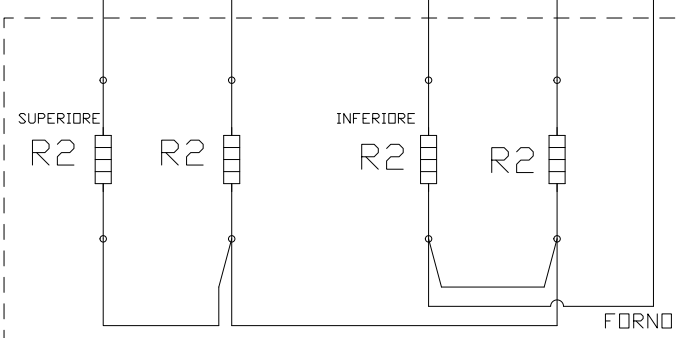
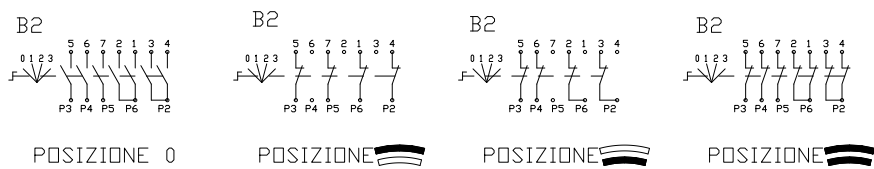
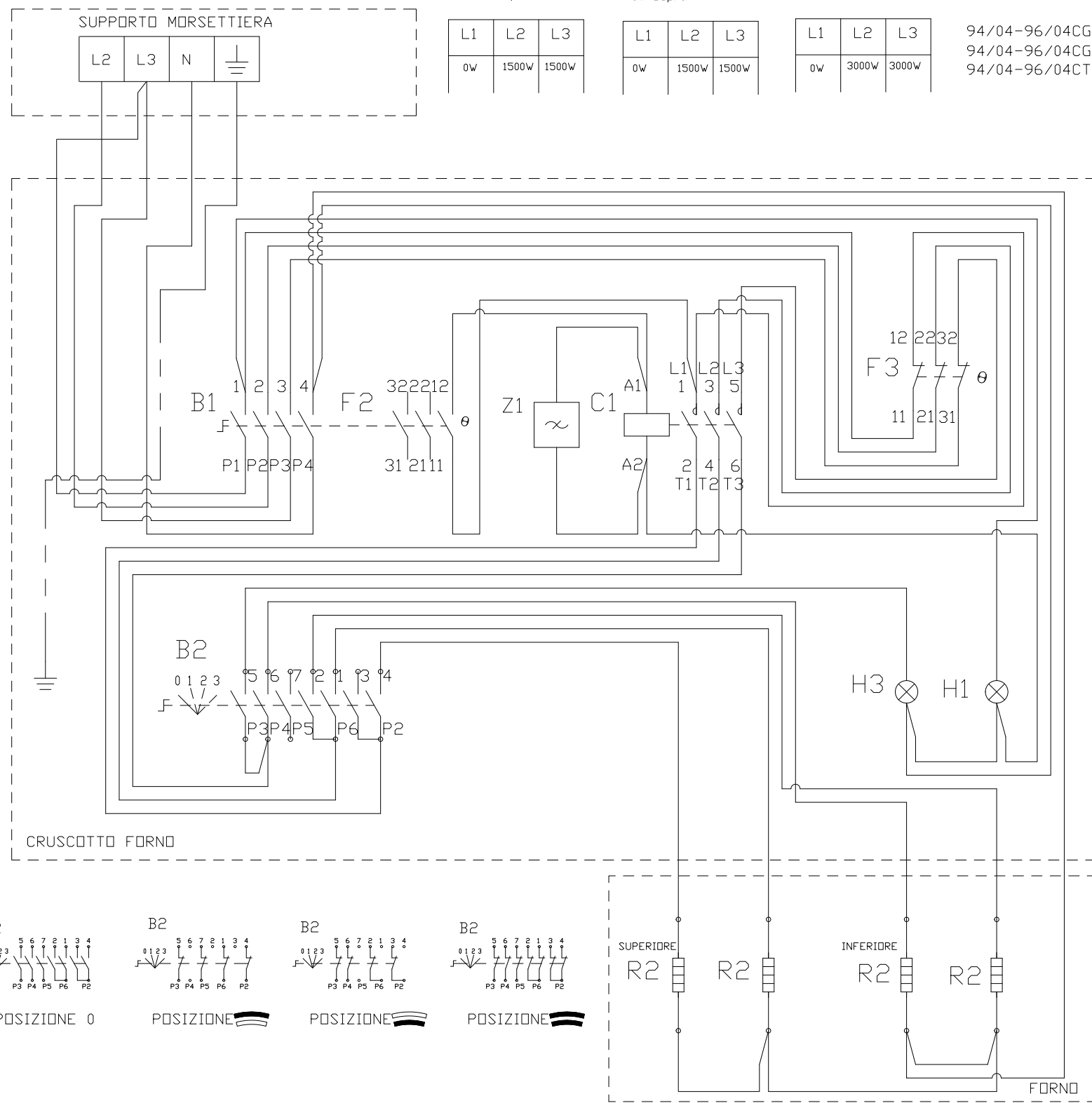

B2

POS. 0						
1	2	3	4	5	6	7
P2						
P3						
P4						
P5						
P6						

B2

POS. 1						
1	2	3	4	5	6	7
P2		X				
P3			X			
P4				X		
P5					X	
P6	X					

B2

POS. 2						
1	2	3	4	5	6	7
P2		X				
P3			X			
P4				X		
P5					X	
P6	X					

B2

POS. 3						
1	2	3	4	5	6	7
P2		X	X			
P3			X			
P4				X		
P5					X	
P6	X	X				

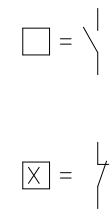
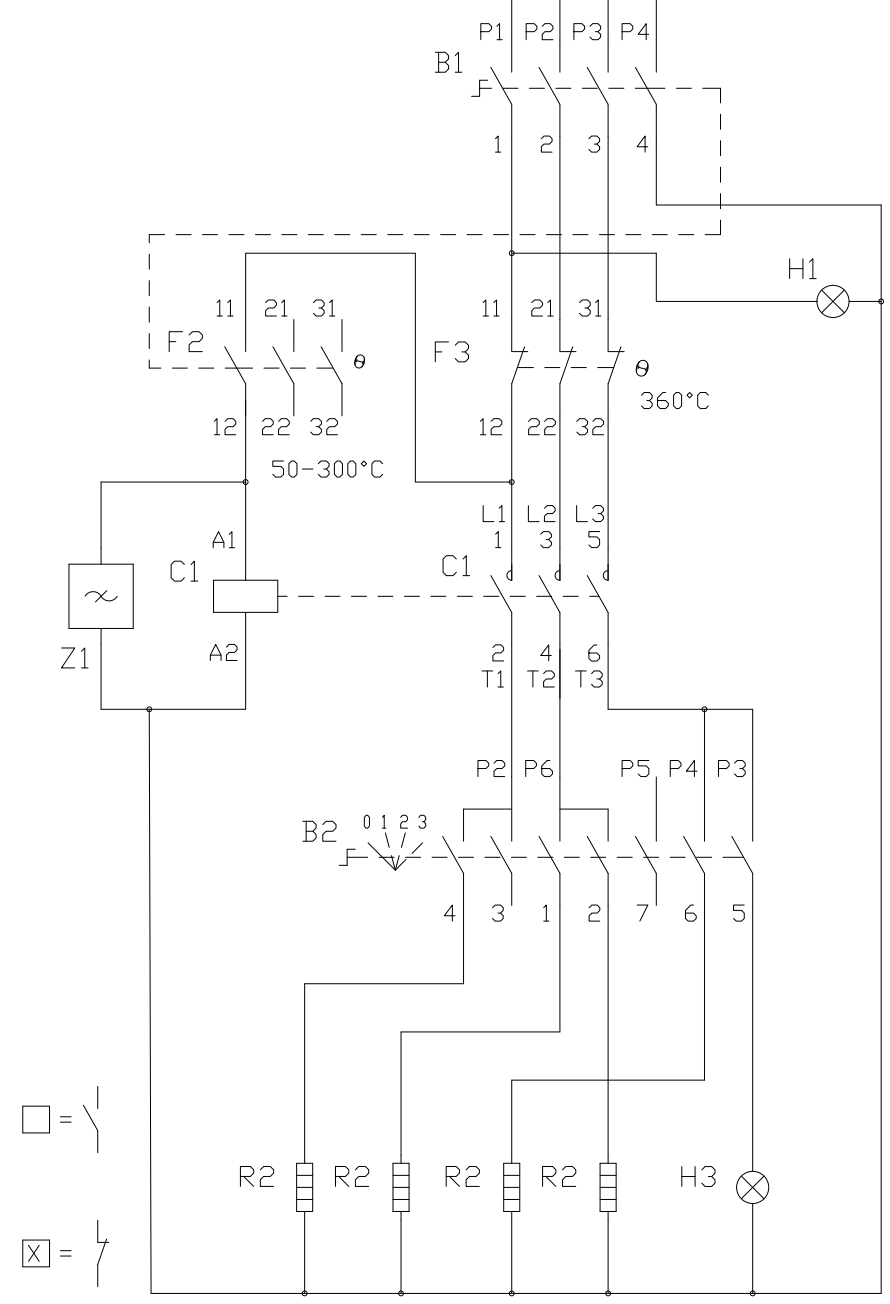

SCHEMA VALIDO SOLO PER FORNO BARON 700/900  
MONTATO SU MACCHINE CON TOP CON ALIMENTAZIONE ELETTRICA:  
CUCINE ELETTRICHE, CUCINE VETROCERAMICA E TUTTAPIASTRA ELETTRICO;

ATTENZIONE; ARRIVO LINEA SOLO ED ESCLUSIVAMENTE PARTE TOP  
E NON NELLA MORSETTIERA DEL FORNO

B1	COMMUTATORE	COMMUTEUR	OVEN CHANGE-SWITCH	UMSCHALTER
B2	COMMUTATORE FORNO	COMMUTEUR FOUR	OVEN CHANGE-OVER SWITCH	BACKOFEN UMSCHALTER
C1	CONTATTORE DI SICUREZZA	CONTACTEUR DE SECURITE'	SAFETY CONTACTOR	SICHERHEITSSCHUETZ
F2	TERMOSTATO FORNO	THERMOSTAT FOUR	OVEN THERMOSTAT	BACKOFEN THERMOSTAT
F3	TERMOSTATO DI SICUREZZA	THERMOSTAT DE SECURITE'	SAFETY THERMOSTAT	TEMPERATURBEGRENZER
H1	SPIA VERDE	LAMPE GREEN	GREEN PILOTLIGHT	GREEN LAMPE
H3	SPIA FORNO	LAMPE FOUR	OVEN PILOTLIGHT	BACKOFEN LAMPE
MA	MORSETTIERA ARRIVO LINEA	BORNES ARRIVEE LIGNE	TERMINAL BLOCK	ANSCHLUSSKLEMME
R2	RESISTENZA FORNO	RESISTANCE FOUR	OVEN HEATING	BACKOFEN HEIZKORPER
Z1	FILTRO ANTIDISTURBO	FILTRE ANTI PARASITE'	SUPPRESSION FILTER	FUNKENTSTORFILTER

Code	CR1515170	Drawing Description	SCHEMA ELE.FORNO 400V SU TOP ELETTR.-BA	Rev.	00
Author	BOTTEGA	Document Type		Description	
Date	08/06/2021				

21022B	00	PRIMA EMISSIONE	21/06/2021	TEGNER
Rif	Rev	Description	Date	Author



This document is exclusive property of ALI GROUP and should not be distributed, reproduced, into any other format without prior permission of ALI GROUP - Specifications subject to change without prior notice -