

Pos	Art.- Nr.	Bezeichnung
0001	BN4006760	ASS. RAMPA SUPER FT/G 22S M80 900 BARON
0002	CR0584900	SUPPORTO RAMPA TOP CUCINE
0003	CR1176150R	MANOP. COMP. ALB. D.10 CROMATA BARON B18
0005	BN4006960RG	9PFTG803 P. SFT 900 M80 430-LIS. RIC.GAS
0006	MA1030000600	SCHAUFEL [C]
0007	MACM278100	SCHABER [C]
0008	BN4006710	FONDO TOP SUPER FRY TOP GAS M80 900BARON
0009	CR1265740	ASS.FIANCO DX TOP 900 BARON B18
0010	CR1265750	ASS.FIANCO SX TOP 900 BARON B18
0011	CR1225840	SCHIENALE TOP M80 304
0012	BN4006630	ASS.PIANO SUPER FRY TOP 900M80 BARON B18
0013	BN4006170	ASS. TUBO SGOCCIOLATOIO SUPER FRY TOP
0014	CR1176580	SCHUTZGITTER [C] RAUCHABLAUF
0015	BN4005480	ASS. CRUSCOTTO SFT GAS M80 700 BARON B18
0016	BN4005830	ASS.CASSETTO SUPER FRY-TOP M80 700 BARON
0017	BN4007200	ASS. CASSAFUMI SFTG M80 900 OL/BA
0018	BN4004980	BRUCIATORE MULTIG.7.0-10Kw 103_3517_00
0019	CR0736740	REGOLATORE ARIA CUOCIPASTA GAS
0020	BN6A014708	VERSCHRAUBUNG 20X1.5
0021	BN6A010820	ZWINGE M 15x1
0022	BN2568360	FLANSCH [C]
0023	BN2510389	ZUENDFLAMMENBRENNER 200/34700F
0024	BN4006090	SQ.SUPP.CASSAF.SUPER FRY TOP 70-90 OL/BA
0025	CR0585540	VERSCHLUSS [C]
0026	BN4006160	RUBINETTO GAS PEL 22SR 330 BASSETTA DX
0027	BN6A016300	STUETZHUELSE 12MM
0028	BN6A016200	MUTTER [C] 20X1,5 D. 12
0029	CR1366030	CONDUTTURA FLEX D.6 COMPLETA L=500
0030	CR1369150	CONDUTTURA FLEX D.12 L=300
0031	MA1916000	THERMOELEMENT [C] L. 850
0032	BN6A013302	KERZE M 2.4 BACKOFEN S 70 0915035
0033	BN2510698	ZUENDKABEL FTG CTG CBG 70-02 90-04
0034	CR1511210	PIEDINO PER TOP 11/2 INOX REG. 75-84
0035	BN861310850	PIEZOZÄEÄNDER Ä~ 18MM [C]
0036	BN826630420	ABDECKUNG [C]
0037	CR1654629G30ST	KIT UGELLI Q90SFTV/G803
0038	CR1176730	VORDERROHR M80 BARON B18
005a	BN4006990RG	9PFTG813 P. SFT 900 M80 430-RIG. RIC.GAS
005b	BN4007020RG	9PFTG823 P.SFT 900 M80 430-1/3RI.RIC.GAS

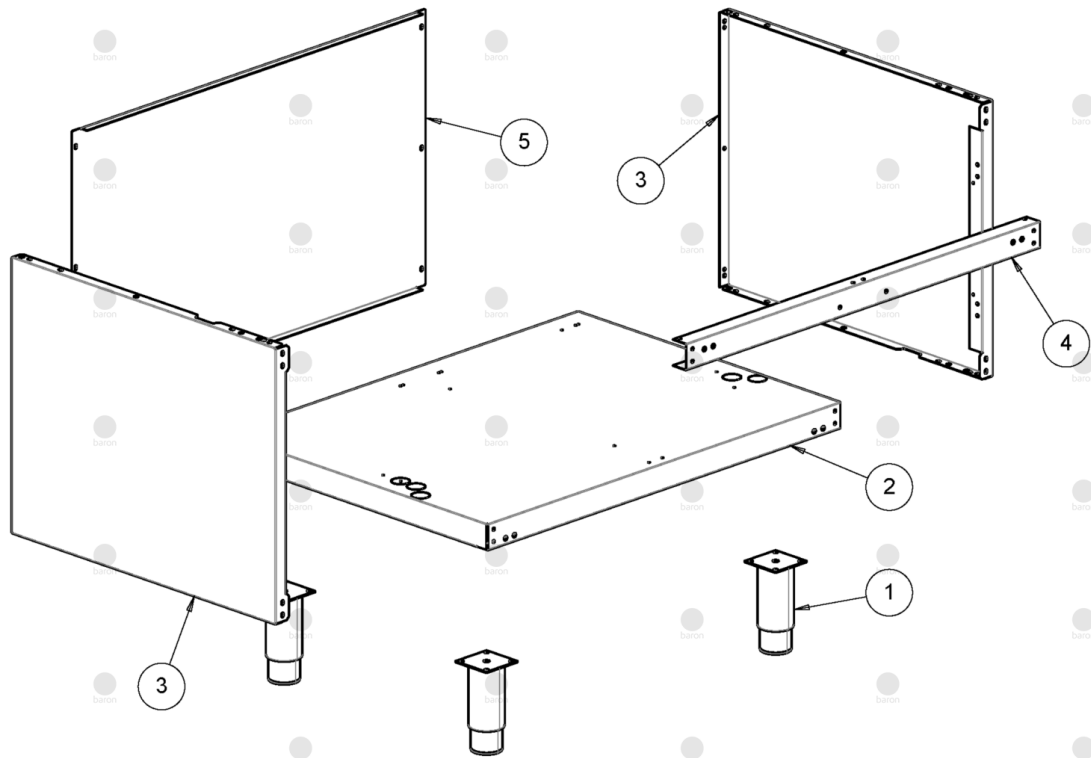

Pos	Art.- Nr.	Bezeichnung
0001	MA6086113	FUSSGRUPPE [C] H. 200
0002	CR1510650	RIPIANO INFER. M80 900 COMUNE OLIS BARON
0003	CR1510610	FIANCO DX-SX BASE 900 COMUNE OLIS BARON
0004	CR0901640	TRAVERSA SUPERIORE BASE VANO M80 BARON
0005	CR1225940	SCHIENALE BASE VANO M80 304